



**COLOUR TELEVISION**  
**INSTRUCTIONS**

Thank you for buying this JVC colour television.  
To make sure you understand how to use your new TV, please read this manual thoroughly before you begin.

**AV-21YG11**  
**AV-21YG21**  
**AV-21WM11**



**Contents**

<b>Safety precautions</b>	<b>2</b>
<b>Preparation</b>	<b>3</b>
1 Confirm which remote control you have .....	3
2 Inserting the batteries .....	3
3 Connecting the aerial and external devices ...	4
4 Connecting the power cord .....	5
5 SETUP TOUR .....	6
<b>Basic operation</b>	<b>7</b>
<b>Remote control buttons and functions</b>	<b>8</b>
ECO SENSOR button .....	8
PICTURE MODE button .....	8
COLOUR SYSTEM button .....	8
SOUND SYSTEM button .....	9
DISPLAY button .....	9
RETURN + button .....	9
MUTING button .....	10
OFF TIMER button .....	10
CHANNEL SCAN button .....	10
PICTURE BOOSTER button .....	10
<b>Viewing teletext programmes</b>	<b>11</b>
<b>Using the TV's menus</b>	<b>13</b>
Basic operation .....	13
INPUT .....	14
VNR .....	14
ON TIMER .....	14
AUTO SHUTOFF .....	15
CHILD LOCK .....	15
BLUE BACK .....	15
AI ECO DISPLAY .....	16
LANGUAGE .....	16
AUTO CH PRESET .....	16
MANUAL CH PRESET .....	17
SKIP .....	18
SETUP TOUR .....	18
TEXT (Teletext Language) .....	18
Picture Adjustments .....	18
<b>TV buttons and parts</b>	<b>19</b>
<b>Using the buttons on the TV</b>	<b>20</b>
<b>Troubleshooting</b>	<b>21</b>
<b>Specifications</b>	<b>22</b>



# Safety precautions

---

## WARNING

**TO PREVENT FIRE OR SHOCK HAZARD, DO NOT EXPOSE THIS APPLIANCE TO RAIN OR MOISTURE.**

## CAUTION

TO ENSURE PERSONAL SAFETY, OBSERVE THE FOLLOWING RULES REGARDING THE USE OF THIS TV.

- Operate only from the power source specified on the TV.
- Avoid damaging the power cord and main plug. When you unplug the TV, pull it out by the main plug. Do not pull on the power cord.
- Never block or cover the cabinet openings for ventilation. Never install the TV where good ventilation is unattainable. When installing this TV, leave spaces for ventilation around the TV more than the minimum distances shown in the diagram.
- Do not allow objects or liquid into the cabinet openings.
- In the event of a fault, unplug the TV and bring to JVC service centre. Do not attempt to repair it by yourself or remove the rear cover.
- The surface of the TV screen is easily damaged. Be very careful with it when handling the TV. Should the TV screen become soiled, wipe it with a soft dry cloth. Never rub it forcefully. Never use any cleaner or detergent on it.
- When you don't use this TV for a long period of time, be sure to disconnect the power plug from the AC outlet.
- The apparatus shall not be exposed to dripping or splashing and that no objects filled with liquids, such as vases, shall be placed on the apparatus.

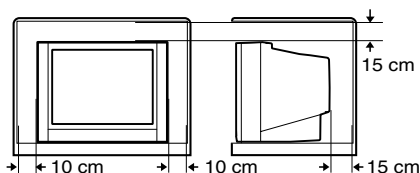

# Preparation

## 1 Confirm which remote control you have

Your TV comes with one of the three remote controls shown below. Functions you can operate differ depending on the type of remote control.

### RM-C92

For TV model:  
AV-21YG21

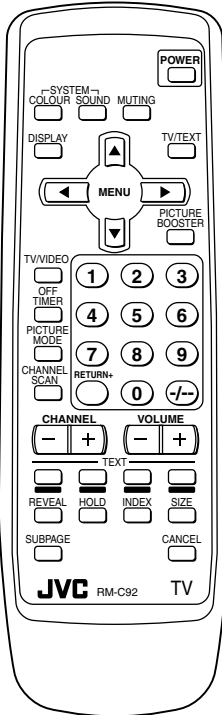

### RM-C375GY

For TV model:  
AV-21YG11

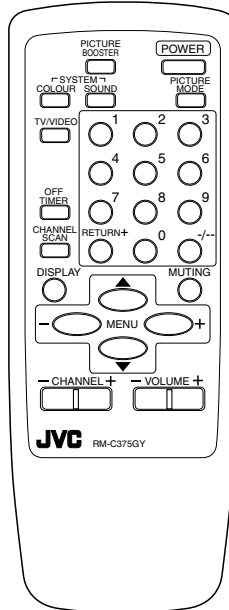

### RM-C364GY

For TV model:  
AV-21WM11

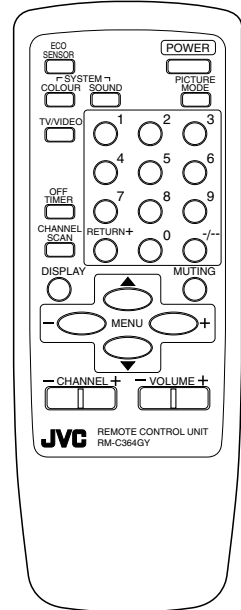

## 2 Inserting the batteries

Correctly insert two batteries, observing the ⊕ and ⊖ polarities and inserting the ⊖ end first.

### CAUTION:

Follow the cautions printed on the batteries.

### Notes:

- Use AA/R6/UM-3 dry cell batteries.
- If the remote control does not work properly, fit new batteries.  
The supplied batteries are for testing, not regular use.

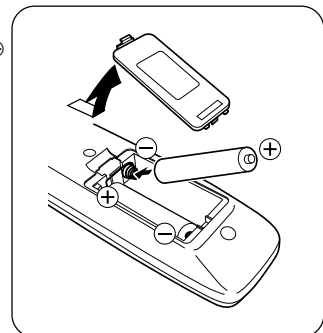

## Preparation

### 3 Connecting the aerial and external devices

- For further details, refer to the manuals provided with the devices you are connecting.
- Connecting cables are not supplied.
- The front and rear AUDIO/VIDEO input jacks are directly connected so that input to either jack is output through both. You cannot provide input to both the front and rear jacks at the same time. Disconnect one input, or use one of the jacks as an output jack only (for monitoring or recording).

#### ■ Connecting the aerial and VCR

##### Connecting the aerial

VHF/UHF outdoor aerial

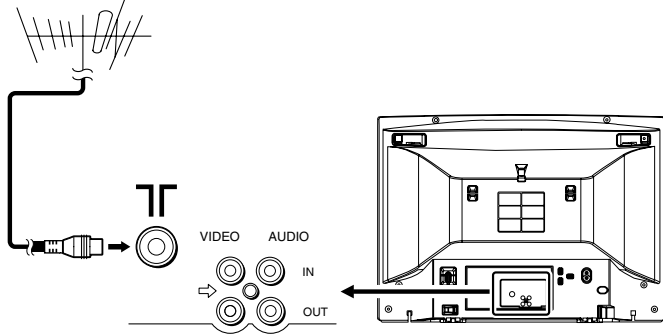

##### Connecting the aerial and VCR

VHF/UHF outdoor aerial

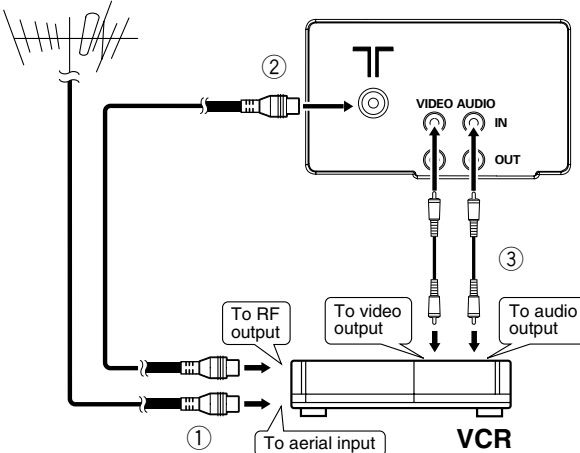

## Preparation

### ■ Connecting other external devices

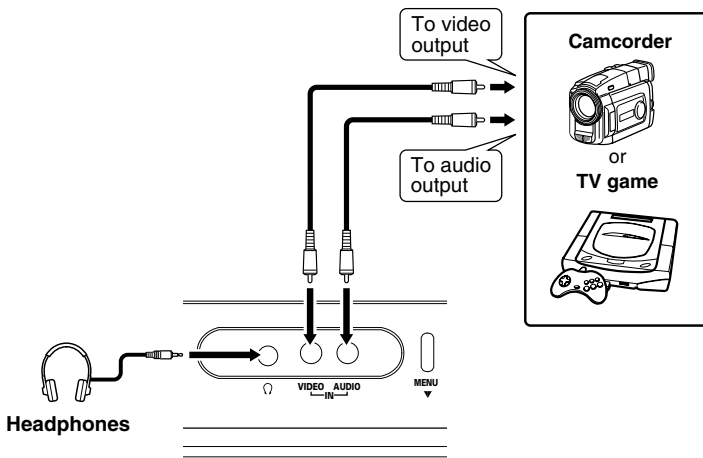
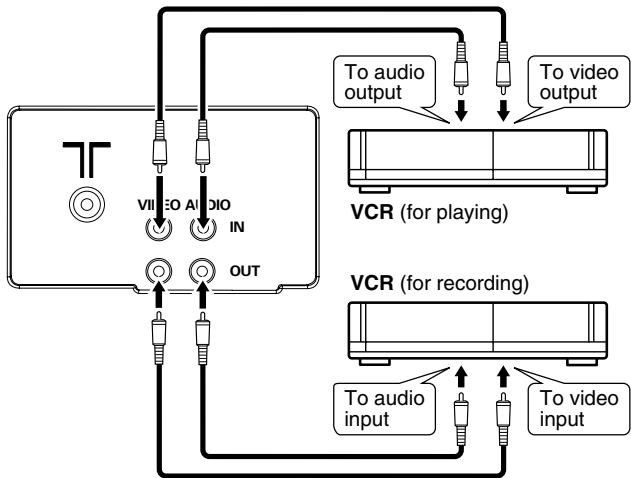

- Use the headphones with a stereo mini jack (3.5 mm in diameter). When you connect the headphones, the TV speakers go off.

## 4 Connecting the power cord

Connect the power cord to the AC outlet.

Operate only from the power source indicated on the rear of the TV.

## 5 SETUP TOUR

When the TV is first turned on, it enters the SETUP TOUR mode, and the JVC logo is displayed. Follow the instructions on the on-screen display to perform the SETUP TOUR.

- In case of resetting that the reason for such as removal, you can set the AUTO CH PRESET function on the "MENU 3" menu. For details, see page 16.

### 1 Press the Main power button on the TV.

The POWER lamp lights. After the JVC logo has been displayed, the TV automatically switches to the language setting mode.



### 2 Press the CHANNEL +/- or the MENU </> buttons to select the on-screen language.

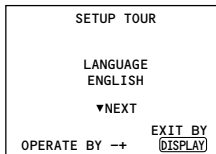

### 3 Press the CHANNEL +/- or the MENU </> buttons to select the teletext language group. For details, see page 18. (For AV-21YG21 only.)



### 4 The AUTO PROGRAMMING function will start and the indicator blinks.

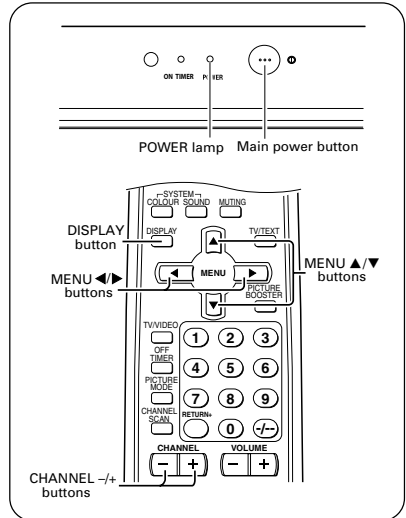
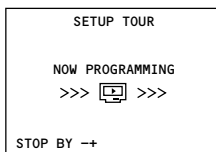

- To stop the AUTO PROGRAMMING function, press the CHANNEL +/- or the MENU </> buttons.

When all the TV channels that can be received on your TV have been preset, the display goes out and the AUTO PROGRAMMING function operation is completed.

- If a TV channel you want to view is not set to the channel, set it with the MANUAL CH PRESET function. For details, see page 17.

### 5 Upon the completion of AUTO PROGRAMMING function, the message below is displayed.

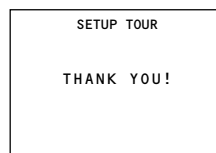

# Basic operation

The illustration below is for the remote control RM-C364GY. Your remote control may not look exactly like the illustration.

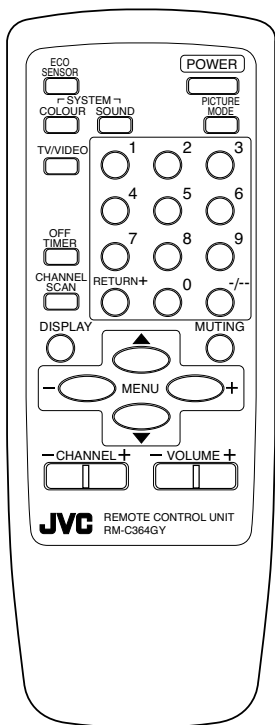

## 1 Press the POWER button to turn your TV on.

- If your TV does not turn on, press the Main power button on the TV then press the POWER button again.
- You can also turn on your TV by pressing any of the following buttons;
  - the CHANNEL  $-/+$  button
  - the Number buttons
  - the TV/VIDEO button

## 2 Select a channel.

- Press the CHANNEL  $-/+$  button.
  - Up/down selection cannot be selected for channels to which the SKIP has been set to "YES". See page 18.
- Press the Number buttons to enter the channel number.
  - If you want to enter a two-digit number, press the  $-/--$  button to select the two digit mode "--", then enter the channel number.

## 3 Press the VOLUME $-/+$ button to adjust the sound.

## 4 To turn your TV off, press the POWER button.

- We recommend that you press the Main power button on the TV to turn the main power off if you do not plan to use your TV for a long time or if you wish to save energy.

### If the picture is not clear:

Press the COLOUR SYSTEM button to select another colour system, see page 8.

### If the sound is not clear:

Press the SOUND SYSTEM button to select another sound system, see page 9.

### Viewing Images from an External Device:

Press the TV/VIDEO button to select the VIDEO mode.

- You can also use the INPUT function to select the VIDEO mode. For details, refer to page 14.

# Remote control buttons and functions

## ECO SENSOR button

< AV-21WM11 only >

You can adjust this TV so that the screen automatically adjusts to the optimum contrast according to the brightness of your room. This function reduces eye strain and the power consumption of this TV.

**Press this button to select the desired mode.**

### AI ECO SENSOR 1:

The AI ECO SENSOR function switches on. Usually, it is recommended to watch the TV in this mode.

### AI ECO SENSOR 2:

The AI ECO SENSOR function switches on. If you feel the screen in the "AI ECO SENSOR 1" mode is too dark, select this mode.

### AI ECO SENSOR OFF:

The AI ECO SENSOR function switches off.

- You can display on the screen the effect of the AI ECO SENSOR function. For details, see "AI ECO DISPLAY" on page 16.

## PICTURE MODE button

You can select one of three picture adjustment settings as you like.

**Press this button to select a mode.**

### BRIGHT:

Heightens contrast and sharpness.

### STANDARD:

Standardizes picture adjustments.

### SOFT:

Softens contrast and sharpness.

- Pressing this button returns all the picture settings in the "MENU 4" to their default settings.

## COLOUR SYSTEM button

If the picture is not clear or no colour appears, change the current colour system to another colour system.

**Press this button to select the colour system.**

**In TV mode (channel 1 to 99 and AV):**

< AV-21YG11/AV-21YG21 only >

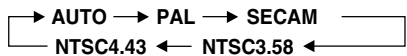

< AV-21WM11 only >



**In VIDEO mode:**

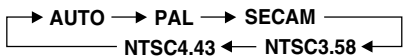

### AUTO:

Automatic colour system selection.

- For the colour systems in each country or region, see the table "Broadcasting systems" on page 22.
- If the picture is not normal in the AUTO mode, change the AUTO mode to another colour system.



## Remote control buttons and functions

---

### SOUND SYSTEM button

---

If the sound is not clear even when the picture appears normal, change the current sound system to another sound system.

**Press this button to select the sound system.**

< AV-21YG11/AV-21YG21 only >

▶ B/G → I → D/K → M

< AV-21WM11 only >

▶ B/G → I → D/K

- For the sound systems in each country or region, see the table “Broadcasting systems” on page 22.
- You cannot select any sound system when in a VIDEO mode.

### DISPLAY button

---

You can continuously display the current channel number or VIDEO mode on the screen.

**Press this button.**

To turn the display off, press this button again.

- When selecting a channel or VIDEO mode with no input signal, indication of selected channel or VIDEO mode becomes fixed on the screen.

### RETURN + button

---

You can set a channel you frequently view to the Return Channel and you can view that channel at any time with one-touch.

**To set the channel to the Return Channel:**

- 1 **Select the channel you want to set to the Return Channel.**
- 2 **Press this button and hold until the message “RETURN PLUS PROGRAMMED!” appears.**

- When you turn off the TV, the Return Channel setting is cancelled.

**To view the Return Channel:**

Press this button.

- You can view two channels (current channel and Return Channel) alternately by pressing this button.

**To cancel the Return Channel setting:**

Press this button and hold until the message “RETURN PLUS CANCELLED!” appears.

**If no channel is set to the Return Channel:**

You can view the channel selected right before the current channel by pressing this button.

## Remote control buttons and functions

---

### MUTING button

---

You can turn the sound off instantly.

#### Press this button.

To turn the sound on, press this button again.

### OFF TIMER button

---

You can set the TV to automatically turn off after a set time.

#### Press this button to select the period of time.

- You can set the period of time to a maximum of 120 minutes in 10 minute increments.
- 1 minute before the OFF TIMER function turns off the TV, "GOOD NIGHT!" appears.

To display the remaining time, press this button once.

To cancel the OFF TIMER function, press this button to set the period of time to "0".

- The OFF TIMER function will not turn off the TV's main power.

### CHANNEL SCAN button

---

You can quickly view all TV channels programmes that you can view on your TV, and search for the programme you want to view.

#### 1 Press this button to start scanning TV channels.

The TV channel programmes are each displayed for several seconds.

- The programmes of TV channels for which the SKIP function is set to "YES" are not displayed. (See page 18.)

#### 2 When you find the programme you want to view, press this button again to stop scanning.

### PICTURE BOOSTER button

---

*< AV-21YG21/AV-21YG11 only >*

When the picture is unclear because the reception level of the TV signal is low, activating the Picture Booster improves the picture clarity in some situations. Repeatedly press the PICTURE BOOSTER button to select the desired mode.

#### HIGH:

The Picture Booster is functioning at maximum.

#### LOW:

The Picture Booster is functioning at minimum.

#### OFF:

The Picture Booster is off.

- If the picture becomes abnormal when you set the Picture Booster to **HIGH**, then set it to **LOW** or **OFF**.

# Viewing teletext programmes

< AV-21YG21 only >

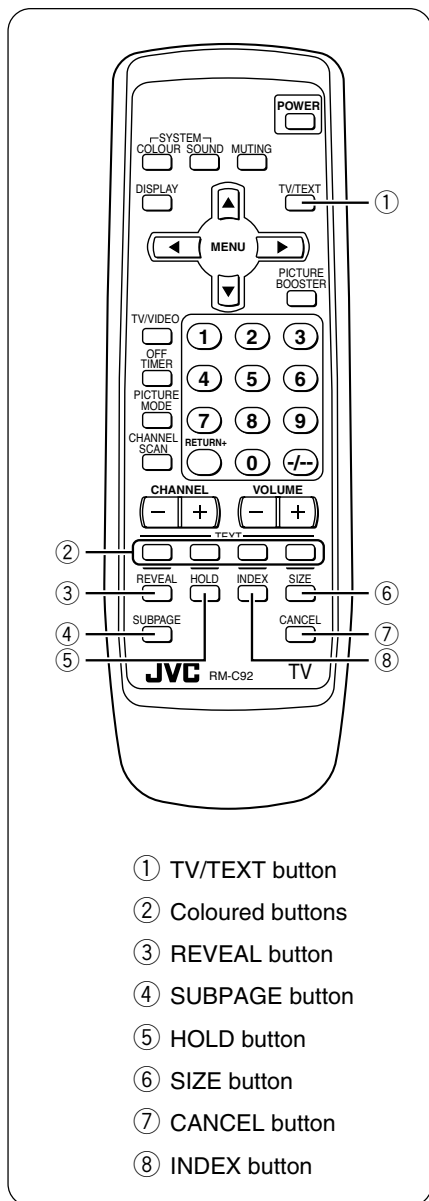

## ■ Basic operation

- 1 Select a TV channel with a teletext programme.
- 2 Press TV/TEXT button to change the TV mode to the teletext mode.

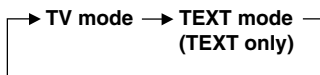

- 3 Select a teletext page by pressing the CHANNEL -/+ button, number buttons or coloured buttons.

To return to the TV mode, press the TV/VIDEO button or the TV/TEXT button.

- If you have trouble receiving teletext broadcasts, consult your local dealer or the teletext station.

## Viewing teletext programmes

---

### REVEAL

---

Some teletext pages include hidden text (such as answers to a quiz).

You can display the hidden text.

**Each time you press the REVEAL button, text is hidden or revealed.**

### HOLD

---

You can hold a teletext page on the screen for as long as you want, even while several other teletext pages are being received.

**Press the HOLD button.**

To cancel the HOLD function, press the HOLD button again.

### CANCEL

---

You can watch a TV programme even when in the teletext mode.

- 1 Press the Number button to enter a page number, or press a coloured button.**

The TV starts searching for a teletext page.

- 2 Press the CANCEL button.**

The TV programme appears.

When the TV finds the teletext page, its page number appears in the upper left of the screen.

- 3 Press the CANCEL button to view the teletext page.**

- Pressing the CANCEL button cannot change the teletext mode to the TV mode.

### INDEX

---

You can return to the index page instantly.

**Press the INDEX button.**

Returns to teletext page 100 or a page which has been specified.

### SUBPAGE

---

Some teletext pages include sub-pages that are automatically displayed.

You can hold any sub-page, or view it at any time.

- 1 Press the SUBPAGE button to operate the Sub-page function.**
- 2 Press the Number buttons to enter a sub-page number.**

**Example:**

3rd sub-page → press 0, 0, 0 and 3.

- You can also select a sub-page by pressing the red or green button.

To cancel the Sub-page function, press the SUBPAGE button again.

### SIZE

---

You can double the height of the teletext display.

**Press the SIZE button.**

The teletext display changes cyclically.

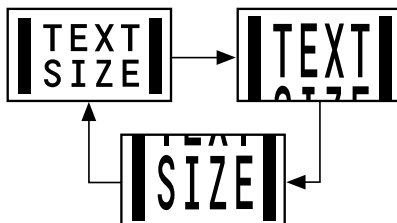

# Using the TV's menus

This TV has a number of functions you can operate using the menus. To use all your TV's functions fully, you need to understand how to use the menus.

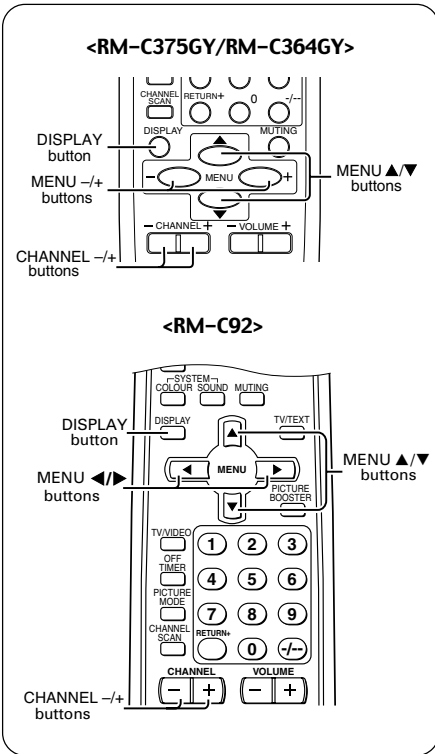

## 2 Repeatedly press the MENU ▲/▼ buttons to display a desired menu.

- If you hold down the ▼ button, the next menu is displayed.
- If the selected function is on the first line, pressing the ▲ button displays the preceding menu.

## 3 Repeatedly press the MENU ▲/▼ buttons to select a desired function.

## 4 Press the CHANNEL -/+ or the MENU ◀/▶ buttons to change function settings.

Example:

Changes the AUTO SHUTOFF setting.

MENU	2
☐ AUTO SHUTOFF	OFF
CHILD LOCK	OFF
BLUE BACK	ON
AI ECO DISPLAY	ON
SELECT BY ▼▲	EXIT BY
OPERATE BY →	DISPLAY

↔

MENU	2
☐ AUTO SHUTOFF	ON
CHILD LOCK	OFF
BLUE BACK	ON
AI ECO DISPLAY	ON
SELECT BY ▼▲	EXIT BY
OPERATE BY →	DISPLAY

- With some functions, the operation method may differ.

## 5 Press the DISPLAY button to turn the display off.

- To operate a menu using the buttons on the front panel of the TV, refer to “Operating menus” on page 20.

## ■ Basic operation

### 1 Press the MENU ▲/▼ buttons.

One of the 4 menus is displayed.

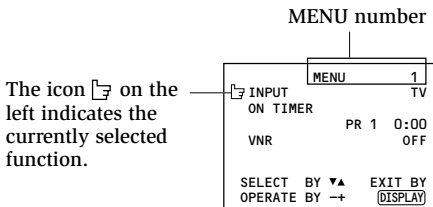

# Using the TV's menus

## INPUT

You can view images from VCRs or other devices connected to your TV.

- 1 Press **MENU ▲/▼** to display the "MENU 1" menu, then select "INPUT".

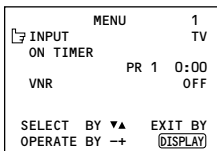

- 2 Press **CHANNEL -/+** or **MENU ◀/▶** to select the VIDEO mode.  
TV mode changes to VIDEO mode.

## VNR

< AV-21WM11 only >

You can reduce the picture noise.

- 1 Press **MENU ▲/▼** to display the "MENU 1" menu, then select "VNR".

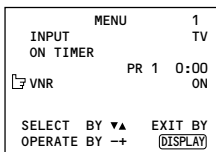

- 2 Press **CHANNEL -/+** or **MENU ◀/▶** to select "ON".  
To cancel the VNR function, select "OFF".

## ON TIMER

Your TV will automatically turn on and tune into the channel you set after the period of time you set.

- 1 Press **MENU ▲/▼** to display the "MENU 1" menu, then select "ON TIMER".

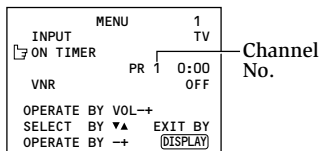

- 2 Press **CHANNEL -/+** or **MENU ◀/▶** to select a channel you want to view when the TV turns on.
- 3 Press **VOLUME -/+** to select the period of time after which you want to turn on the TV.

The ON TIMER function starts.

- Each time you press the button, the period of time changes in 15 minute intervals (up to 12 hours).

To cancel the ON TIMER function, press the **VOLUME -/+** button to set the period of time to "0:00".

- 4 Press **DISPLAY** to turn the display off.

- If you turn off the TV's main power by pressing the Main power button, the ON TIMER function is canceled.
- If you do not turn off the TV after starting the ON TIMER function, the channel will automatically switch to the channel set for the ON TIMER function.

### When the time set for the ON TIMER function is reached:

The TV automatically turns on and the channel set for the ON TIMER function is displayed.

- For safety reasons the TV will automatically turn off if no operations are made within approximately two hours after the TV is turned on with the ON TIMER function.
- The OFF TIMER function and AUTO SHUTOFF function have priority over the ON TIMER function.

## Using the TV's menus

### AUTO SHUTOFF

You can set your TV to turn off if no signals are received for about 15 minutes or longer after the end of a broadcast.

- 1 Press **MENU ▲/▼** to display the "MENU 2" menu, then select "AUTO SHUTOFF".

MENU	2
AUTO SHUTOFF	ON
CHILD LOCK	ON
BLUE BACK	ON
AI ECO DISPLAY	ON
SELECT BY ▼▲	EXIT BY
OPERATE BY →	DISPLAY

- 2 Press **CHANNEL -/+** or **MENU ◀/▶** to select "ON".

To cancel the AUTO SHUTOFF function, select "OFF".

- The AUTO SHUTOFF function does not turn off the TV's main power.
- The AUTO SHUTOFF will not work for a VIDEO mode.

### CHILD LOCK

You can disable the front control buttons of the TV.

When this function is set to "ON", the TV can be operated using only the remote control.

Use this function to prevent children from operating the TV without parental consent.

- 1 Press **MENU ▲/▼** to display the "MENU 2" menu, then select "CHILD LOCK".

MENU	2
AUTO SHUTOFF	ON
CHILD LOCK	ON
BLUE BACK	ON
AI ECO DISPLAY	ON
SELECT BY ▼▲	EXIT BY
OPERATE BY →	DISPLAY

- 2 Press **CHANNEL -/+** or **MENU ◀/▶** to select "ON".

To cancel the CHILD LOCK function, select "OFF".

- The CHILD LOCK function is canceled when you turn the power off.

### BLUE BACK

If no signal is being received or the signal is very weak, a blue screen automatically becomes the picture background.

If you wish to continue viewing the poor picture, you must set the BLUE BACK function to "OFF".

- 1 Press **MENU ▲/▼** to display the "MENU 2" menu, then select "BLUE BACK".

MENU	2
AUTO SHUTOFF	ON
CHILD LOCK	ON
BLUE BACK	ON
AI ECO DISPLAY	ON
SELECT BY ▼▲	EXIT BY
OPERATE BY →	DISPLAY

- 2 Press **CHANNEL -/+** or **MENU ◀/▶** to select "ON".

To cancel the BLUE BACK function, select "OFF".

## Using the TV's menus

### AI ECO DISPLAY

< AV-21WM11 only >

You can display on the screen the effect of the AI ECO SENSOR function.

- 1 Press **MENU ▲/▼** to display the "MENU 2" menu, then select "AI ECO DISPLAY".

MENU	2
AUTO SHUTOFF	ON
CHILD LOCK	ON
BLUE BACK	ON
AI ECO DISPLAY	ON
SELECT BY ▼▲ EXIT BY (DISPLAY)	
OPERATE BY →	

- 2 Press **CHANNEL -/+** or **MENU ◀/▶** to select "ON".

The clover mark indicating the brightness of your room is displayed for several seconds each time the brightness changes. The number of clover marks displayed on screen increases as your room becomes darker.

To cancel the AI ECO DISPLAY function, select "OFF".

### LANGUAGE

You can select the language for the on-screen display.

- 1 Press **MENU ▲/▼** to display the "MENU 3" menu, then select "LANGUAGE".

MENU	3
AUTO CH PRESET	
MANUAL CH PRESET	
SETUP TOUR	
LANGUAGE	ENGLISH
SELECT BY ▼▲ EXIT BY (DISPLAY)	
OPERATE BY →	

- 2 Press **CHANNEL -/+** or **MENU ◀/▶** to select language.

The on-screen display indications are in the selected language.

### AUTO CH PRESET

You can automatically preset all TV channels that can be received by your TV to channels.

- 1 Press **MENU ▲/▼** to display the "MENU 3" menu, then select "AUTO CH PRESET".

MENU	3
AUTO CH PRESET	
MANUAL CH PRESET	
SETUP TOUR	
LANGUAGE	ENGLISH
SELECT BY ▼▲ EXIT BY (DISPLAY)	
OPERATE BY →	

- 2 Press **CHANNEL -/+** or **MENU ◀/▶** to start the AUTO CH PRESET function.

">>> ON SEARCH" is displayed on the screen.

When all the TV channels that can be received on your TV have been preset, the display goes out and the AUTO CH PRESET function operation is completed.

#### To stop the AUTO CH PRESET:

Press the **CHANNEL -/+** or the **MENU ◀/▶** buttons.

- The AUTO CH PRESET function does not preset a TV channel to the AV channel (channel number 0).
- If the TV cannot preset the TV channel you want to view, preset it manually. For details, see "MANUAL CH PRESET" on page 17.



# Using the TV's menus

## MANUAL CH PRESET

You can manually preset desired TV channels to desired channels.

- 1 Press **MENU ▲/▼** to display the “MENU 3” menu, then select “MANUAL CH PRESET”.

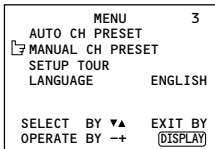

- 2 Press **CHANNEL -/+** or **MENU ◀/▶**. The sub-menu is displayed.

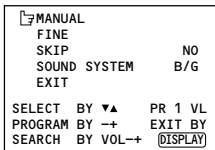

- The channel number is displayed as a PR number. For example, channel 1 will be displayed as PR 1. However, the AV channel will be displayed as AV.

- 3 Press **CHANNEL -/+** or **MENU ◀/▶** to select the channel number.

- 4 Press **VOLUME -/+** to start searching for the TV channel.

“>>>” or “<<<<” is displayed on the screen.

When the TV finds a TV channel, the “>>>” or “<<<<” display goes out, and the TV channel is preset to the currently selected channel number.

- If the TV channel you want to preset is not displayed, repeat step 4 until the TV finds the TV channel you want to preset.
- To stop the MANUAL CH PRESET function, press any button other than the VOLUME -/+ button.

If the picture is not clear:

Fine-tune the TV channel.

- 1 Press **MENU ▲/▼** to select “FINE”.

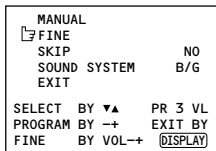

- 2 Hold **VOLUME -/+** down to fine-tune the TV channel so that the best image is displayed on screen.

“>” or “<” indicates that the TV is fine-tuning the TV channel.

If the sound is not clear:

- 1 Press **MENU ▲/▼** to select “SOUND SYSTEM”.

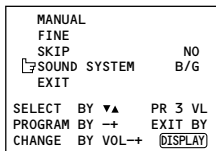

- 2 Press **VOLUME -/+** to select the appropriate sound system.

- For the sound systems in each country or region, refer to the table “Broadcasting systems” on page 22.

- 5 Press **MENU ▲/▼** to select “MANUAL”.

- 6 Repeat steps 3 to 5 if you want to preset another TV channel to a channel.

## Using the TV's menus

### SKIP

You can set undesired channels to be skipped. Channels set to be skipped cannot be selected by the CHANNEL -/+ buttons or the CHANNEL SCAN button.

- Channels to which TV channels have not been preset are automatically set to be skipped.

- 1 Press **MENU ▲/▼** to display the "MENU 3" menu, then select "MANUAL CH PRESET".
- 2 Press **CHANNEL -/+** or **MENU ◀/▶**.  
The sub-menu is displayed.
- 3 Press **MENU ▲/▼** to select "SKIP".

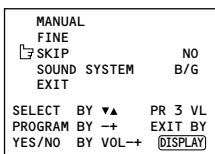

- 4 Press **CHANNEL -/+** to select the channel you want to skip.
- 5 Press **VOLUME -/+** to select "YES".  
The channel is set to be skipped.  
To cancel the SKIP function, select "NO".
- 6 Repeat steps 4 and 5 if you want to set another channel to skip.

### SETUP TOUR

You can start the SETUP TOUR function.

- 1 Press **MENU ▲/▼** to display the "MENU 3" menu, then select "SETUP TOUR".

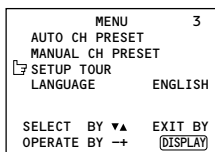

- 2 Press **CHANNEL -/+** or **MENU ◀/▶**.  
JVC logo appears and the SETUP TOUR function will start.  
For details, see page 6.

### TEXT (Teletext Language)

< AV-21YG21 only >

You can view a Farsi teletext programme.

- 1 Press **MENU ▲/▼** to display the "MENU 3" menu, then select "LANGUAGE".
- 2 Press **CHANNEL -/+** or **MENU ◀/▶** to select Arabic or Persian.
- 3 Press **MENU ▼** to select TEXT function.
- 4 Press **CHANNEL -/+** or **MENU ◀/▶** to select Farsi.  
Select Arabic to view an Arabic teletext programme.

### Picture Adjustments

You can adjust the picture as you like.

- 1 Press **MENU ▲/▼** to display the "MENU 4" menu.

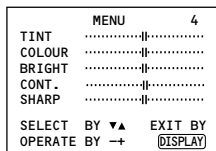

- 2 Press **MENU ▲/▼** to select an item and press **CHANNEL -/+** or **MENU ◀/▶** to adjust it.

**TINT\*** - : Reddish + : Greenish  
**COLOUR** - : Lighter + : Deeper  
**BRIGHT** - : Darker + : Brighter  
**CONT.** - : Lower + : Higher  
**SHARP** - : Softer + : Sharper

\* TINT (tint) is displayed only when viewing images from NTSC3.58 or NTSC4.43 colour systems.

# TV buttons and parts

< AV-21YG21/AV-21YG11 >

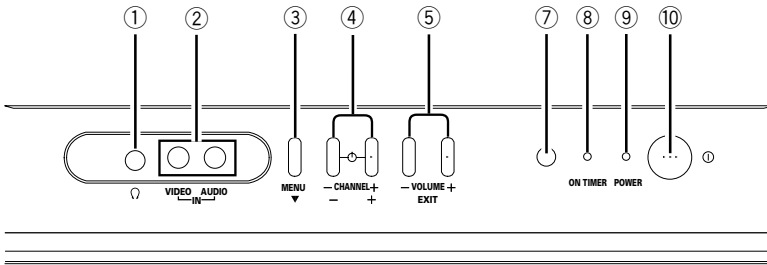

< AV-21WM11 >

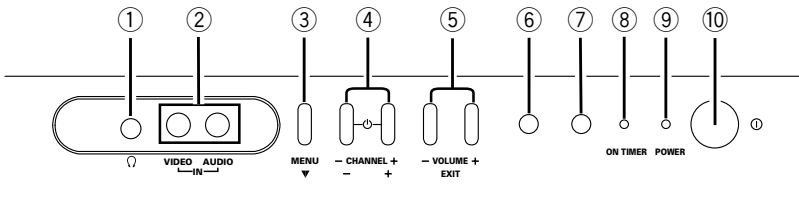

- ① Headphone jack
- ② VIDEO/AUDIO terminal
- ③ MENU button
- ④ CHANNEL +/- buttons
- ⑤ VOLUME +/- buttons

- ⑥ ECO sensor
- ⑦ Remote control sensor
- ⑧ ON TIMER lamp
- ⑨ POWER lamp
- ⑩ Main power button

# Using the buttons on the TV

---

## Basic operation

---

Check to make sure the CHILD LOCK function is set to “OFF”. When the CHILD LOCK function is set to “ON”, the TV cannot be operated using the front control buttons. For details, see “CHILD LOCK” on page 15.

- 1 Press CHANNEL  $-/+$  to turn the TV on from standby mode.
- 2 Press CHANNEL  $-/+$  to select a channel.
- 3 Press VOLUME  $-/+$  to adjust the volume.
- 4 To turn your TV off, press the Main power button to turn off the TV's main power.

### To change the TV mode to the VIDEO mode:

- Press the TV/VIDEO button if the TV has one. See page 7.
- If the TV has no TV/VIDEO button, select the VIDEO mode with the INPUT function in “MENU 1”.

## Operating menus

---

You can operate functions in menus using the front control buttons on the TV.

- 1 Press MENU  $\blacktriangledown$  to display a menu.
- 2 Press MENU  $\blacktriangledown$  repeatedly to display the menu you want to use.
- 3 Press MENU  $\blacktriangledown$  to select the desired function or item.
- 4 Press CHANNEL  $-/+$  or VOLUME  $-/+$  to carry out the desired operation.  
For details, see the description for each function.
- 5 Press VOLUME  $-/+$  to turn the menu display off.

### To turn the sub-menu display off:

- 1 Press MENU  $\blacktriangledown$  to select “EXIT”.

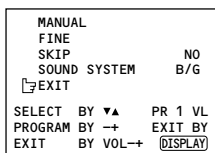

- 2 Press VOLUME  $-/+$  to turn the display off.

# Troubleshooting

---

If there is no picture or the TV does not operate normally, make sure the problem isn't due to the reasons indicated below.

If the problem persists even after taking the measures indicated, please contact a service technician.

## **Cannot turn the TV on**

---

- Press the Main power button on the TV.
- Connect the power cord to the AC outlet.

## **The screen turns blue**

---

- Is the BLUE BACK function on?  
(see page 15.)

## **Remote control inoperable**

---

- Replace the batteries. (see page 3.)

## **Buttons on front of the TV do not work**

---

- Switch the CHILD LOCK function off.  
(see page 15.)

## **TV does not respond immediately**

---

- Press the main power button on the TV to turn off the main power. Press the main power button again to turn on the TV. If the TV returns to a normal state, operation is normal.

## **The TV turns off suddenly**

---

- Is the OFF TIMER function set to operate?  
(see page 10.)
- Is the AUTO SHUTOFF function on?  
(see page 15.)
- Have you not performed an operation for about two hours after the TV was switched on by the ON TIMER function? (see page 14.)  
If you don't perform an operation within about two hours, the TV is automatically switched off for safety.

## **Poor sound**

---

- Press the SOUND SYSTEM button to select another sound system. (see page 8.)

## **Poor picture**

---

- Press the COLOUR SYSTEM button to select another colour system. (see page 8.)
- Adjust the picture settings. (see page 18.)
- Set the Picture mode to STANDARD.  
(see page 8.)
- If noise (snow) totally blocks out the picture, check the following.
  - Have the TV and aerial been connected properly?
  - Has the aerial cable been damaged?
  - Is the aerial pointing in the right direction?
  - Is the aerial itself faulty?
- If the TV or aerial suffer interference from other equipment, stripes or noise may appear in the picture. Move any equipment which can cause interference away from the TV.
- If the TV or aerial suffer interference from signals reflecting from mountains or buildings, double-pictures (ghosting) will occur. Change the aerial's direction or replace it with an aerial with better directionality.
- When a white and bright still image (such as a white dress) is displayed on the screen, the white part may look as if it is coloured. When the image disappears from the screen, the unnatural colours will also disappear.

## **The TV turns on suddenly**

---

- Is the ON TIMER function set to operate?  
(see page 14.)

## **The TV channel changes suddenly**

---

- Is the ON TIMER function set to operate?  
(see page 14.)

## **No receivable teletext programme**

---

< AV-21YG21 only >

- Select a channel with teletext information. You cannot watch teletext recorded on a video tape.

# Specifications

## TV RF systems

AV-21YG11/AV-21YG21: B, G, I, D, K, M  
 AV-21WM11: B, G, I, D, K

## Colour systems

AV-21YG11/AV-21YG21: PAL, SECAM, NTSC 3.58 MHz, NTSC 4.43 MHz  
 AV-21WM11: < For TV mode >  
 PAL, SECAM  
 < For VIDEO mode >  
 PAL, SECAM NTSC3.58MHz, NTSC4.43 MHz

## Receiving channels

VHF low channel (VL), VHF high channel (VH), UHF channel (U)  
 Receives cable channels in mid band, super band and hyper band.

## External input / output

INPUT: VIDEO input (RCA), AUDIO input (RCA)  
 OUTPUT: VIDEO output (RCA), AUDIO output (RCA)  
 Headphone jack: stereo mini jack (3.5 mm diameter)

## Teletext system (AV-21YG21 only)

FLOF (Fastext), WST (World Standard Text)

## Language displayed by teletext (AV-21YG21 only)

English, Lithuanian, Russian, Czechoslovakian, Ukrainian, Latvian, Romanian, Hungarian, Arabic, Persian

## Accessories

- Remote control unit: AV-21YG21: RM-C92  
 AV-21YG11: RM-C375GY  
 AV-21WM11: RM-C364GY
- AA / R6 / UM-3 dry cell battery x 2

*Design and specifications subject to change without notice.*

## Broadcasting systems

Area	Country or Region	System	
		Colour	Sound
Asia, Middle East	Bahrain, Kuwait, Oman, Qatar, United Arab Emirates, Yemen, etc. Indonesia, Malaysia, Singapore, Thailand, India, etc.	PAL	B/G
	China, Vietnam, etc.	PAL	D/K
	Hong Kong, etc.	PAL	I
	Islamic Republic of Iran, Lebanon, Saudi Arabia, etc.	SECAM	B/G
	Philippines, Taiwan, Myanmar, etc.	NTSC	M
Europe	Russia, etc.	SECAM	D/K
	Czech Republic, Poland, etc.	PAL	D/K
	Germany, Holland, Belgium, etc.	PAL	B/G
	UK, etc.	PAL	I
Oceania	Australia, New Zealand, etc.	PAL	B/G
Africa	Republic of South Africa, etc.	PAL	I
	Nigeria, etc.	PAL	B/G
	Egypt, Morocco, etc.	SECAM	B/G





**JVC**  
VICTOR COMPANY OF JAPAN, LIMITED